



**LAMPADINE STANDARD**

STANDARD LAMPS

---

**LAMPADINE SUPERWHITE**

SUPERWHITE LAMPS

---

**KIT LED**

LED KITS

---

**LAMPADE ROTANTI**

REVOLVING LIGHTS

---

**FARI AUSILIARI A LED**

AUXILIARY LED LIGHTS

---

**FARI AUSILIARI ALOGENI**

HALOGEN AUXILIARY LIGHTS

---

**LUCI E LAMPADINE**  
-  
**LIGHTS AND LAMPS**



**CarLight**  
TOP QUALITY

### H1- P14,5s

Lampadina alogena

Halogen lamp

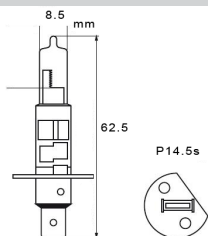

### H2 - X511

Lampadina alogena

Halogen lamp

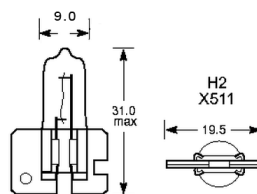

12801/BOX	1pz	12V	55W	BOX	(E)
12801/BLISTER	1pz	12V	55W	BLISTER	(E)
12821/BOX	1pz	12V	100W	BOX	
12821/BLISTER	1pz	12V	100W	BLISTER	
24801/BOX	1pz	24V	70W	BOX	(E)

12813/BOX	1pz	12V	55W	BOX	
12813/BLISTER	1pz	12V	55W	BLISTER	





### H3 - PK22s

Lampadina alogena

Halogen lamp

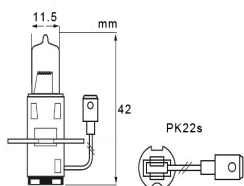

12822/BOX	1pz	12V	100W	BOX
12822/BLISTER	1pz	12V	100W	BLISTER

### H4- P43t

Lampadina alogena

Halogen lamp

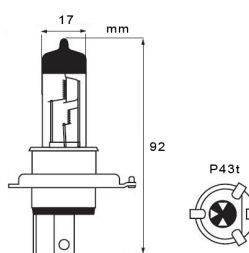

12803/BOX	1pz	12V	60-55W	BOX	(E)
12803/BLISTER	1pz	12V	60-55W	BLISTER	(E)
24803/BOX	1pz	24V	75-70W	BOX	(E)

### H6W - BAX9s

Lampadina alogena

Halogen lamp

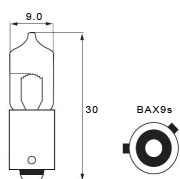

12837/BOX	1pz	12V	6W	BOX
12837/BLISTER	1pz	12V	6W	BLISTER

### H7- PX26d

Lampadina alogena

Halogen lamp

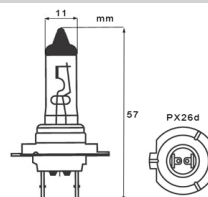

12805/BOX	1pz	12V	55W	BOX	(E)
12805/BLISTER	1pz	12V	55W	BLISTER	(E)
24805/BOX	1pz	24V	70W	BOX	(E)

### H10 - PY20d

Lampadina alogena

Halogen lamp

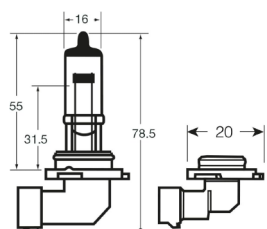

12817/BOX	1pz	12V	42W	BOX
-----------	-----	-----	-----	-----

### H15 - PGJ23t-1

Lampadina alogena

Halogen lamp

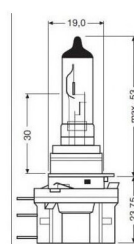

12819/BOX	1pz	12V	15-55W	BOX	(E)
-----------	-----	-----	--------	-----	-----

### H16 - PGJ19-3

Lampadina alogena

Halogen lamp

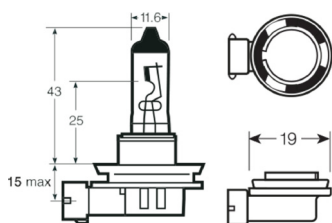

12820/BOX	1pz	12V	19W	BOX
-----------	-----	-----	-----	-----

### R2- P45t

Lampadina asimmetrica

Asymmetric lamp

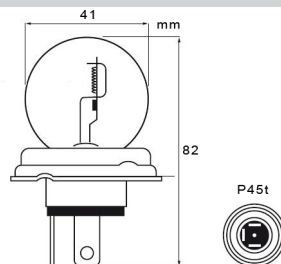

12806/BOX	1pz	12V	45-40W	BOX	(E)
12806/BLISTER	1pz	12V	45-40W	BLISTER	(E)

### T4W - BA9s

Lampadina micro

Micro lamp

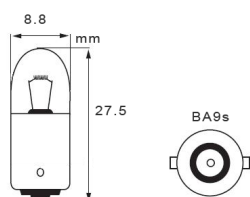

12812/BOX	1pz	12V	4W	BOX	(E)
12812/BLISTER	2pz	12V	4W	BLISTER	(E)
24812/BOX	1pz	24V	4W	BOX	

### P21W- BA15s

Lampadina 1 filamento

Single filament lamp

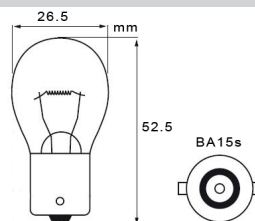

12807/BOX	1pz	12V	21W	BOX	(E)
12807/BLISTER	2pz	12V	21W	BLISTER	(E)
24807/BOX	1pz	24V	21W	BOX	(E)

### P21W- BA15s

Lampadina 1 filamento

Single filament lamp

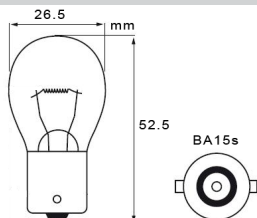

12830/BOX	1pz	12V	21W	BOX	(E)
12830/BLISTER	2pz	12V	21W	BLISTER	(E)

### PY21W- BAU15s

Lampadina 1 filamento

Single filament lamp

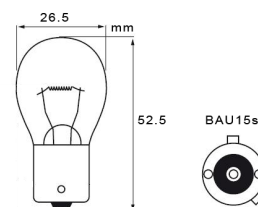

12829/BOX	1pz	12V	21W	BOX	(E)
12829/BLISTER	2pz	12V	21W	BLISTER	(E)



## P21/5W - BAY15d

Lampadina 2 filamenti

Double filament lamp

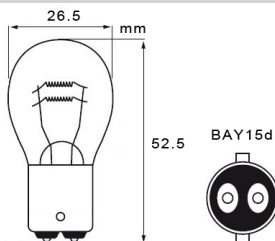

12808/BOX	1pz	12V	21-5W	BOX	(E)
12808/BLISTER	2pz	12V	21-5W	BLISTER	(E)
24808/BOX	1pz	24V	21-5W	BOX	(E)

## P21/4W- BAZ15d

Lampadina 2 filamenti

Double filament lamp



12841/BOX	1pz	12V	21-4W	BOX
-----------	-----	-----	-------	-----

## R5W - BA15s

Lampadina sferica

Spherical lamp

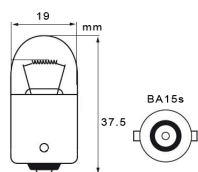

12809/BOX	1pz	12V	5W	BOX	(E)
12809/BLISTER	2pz	12V	5W	BLISTER	(E)
24809/BOX	1pz	24V	5W	BOX	(E)

## R10W - BA15S

Lampadina sferica

Spherical lamp

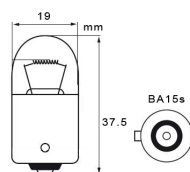

12831/BOX	1pz	12V	10W	BOX	(E)
12831/BLISTER	2pz	12V	10W	BLISTER	(E)
24831/BOX	1pz	24V	10W	BOX	(E)

## T5 - W2x4,6d

Lampadina con zoccolo in vetro

Wedge base lamp

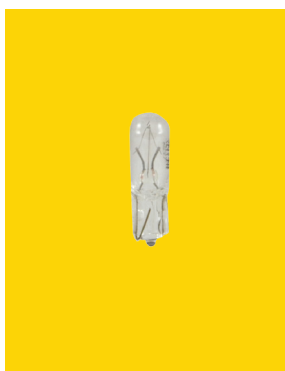
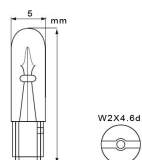

12833/BOX	1pz	12V	1,2W	BOX
12833/BLISTER	2pz	12V	1,2W	BLISTER

## W3,8W - W2,1x9,5d

Lampadina con zoccolo in vetro

Wedge base lamp

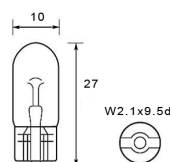

12834/BOX	1pz	12V	1,2W	BOX	(E)
12834/BLISTER	2pz	12V	1,2W	BLISTER	(E)



### W5W - W2,1x9,5d

Lampadina con zoccolo in vetro

Wedge base lamp

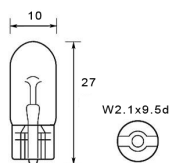

12811/BOX	1pz	12V	5W	BOX	(E)
12811/BLISTER	2pz	12V	5W	BLISTER	(E)
24811/BOX	1pz	24V	5W	BOX	(E)

### W5YW - W2,1x9,5d

Lampadina con zoccolo in vetro

Wedge base lamp

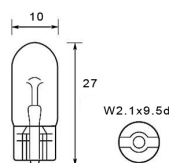

12811A/BOX	1pz	12V	5W	BOX
------------	-----	-----	----	-----

### W16W - W2,1x9,5d

Lampadina con zoccolo in vetro

Wedge base lamp

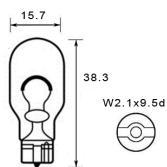

12840/BOX	1pz	12V	16W	BOX
-----------	-----	-----	-----	-----

### W21W - W3x16d

Lampadina con zoccolo in vetro

Wedge base lamp

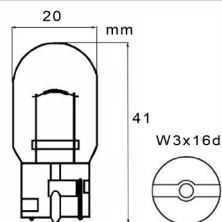

12838/BOX	1pz	12V	21W	BOX
-----------	-----	-----	-----	-----

### W21/5W - W3x16q

Lampadina con zoccolo in vetro

Wedge base lamp

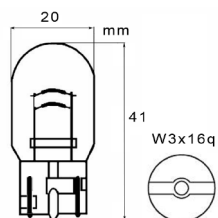

12839/BOX	1pz	12V	21/5W	BOX
-----------	-----	-----	-------	-----

### WY21W - W3x16q

Lampadina con zoccolo in vetro

Wedge base lamp

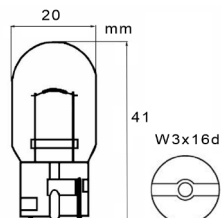

12845/BOX	1pz	12V	21W	BOX
-----------	-----	-----	-----	-----



### WY21/5W- W3x16q

Lampadina con zoccolo in vetro

Wedge base lamp

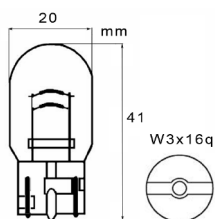

12846/BOX 1pz 12V 21/5W BOX

### C10W - SV8,5-8

Lampadina siluro

Festoon lamp

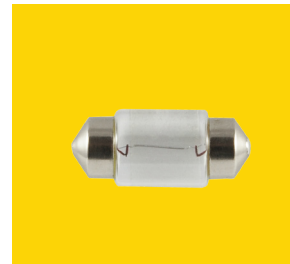
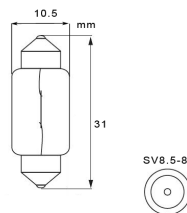

10X31mm

24839/BOX 1pz 24V 10W BOX

### C5W - SV8,5-8

Lampadina siluro

Festoon lamp

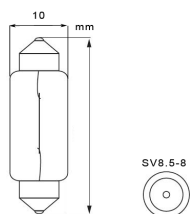

10X36mm

12810/BOX 1pz 12V 5W BOX

24810/BOX 1pz 24V 5W BOX

### C10W - SV8,5-8

Lampadina siluro

Festoon lamp

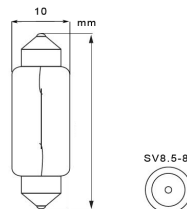

10X36mm

12810/BOX 1pz 12V 10W BOX

### C5W - SV8,5-8

Lampadina siluro

Festoon lamp

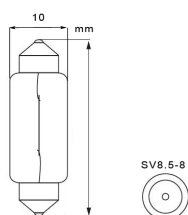

10X41mm

12844/BOX 1pz 12V 5W BOX

### TACHIGRAFO - B8,5d

Lampadina per tachigrafo

Tachograph lamp

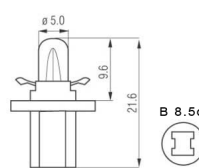

24836/BOX 1pz 24V 1,2W BOX

### TROUSSE H7

Trousse lampadine con H7

Lamp set with H7

12897 9pz 12V PLASTIC BOX

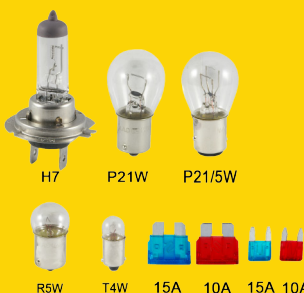

Lampadine omologate per uso stradale

Bulbs approved for road use



Luce bianca solare  
Solar white light



Effetto simil xenon  
Simil xenon effect

3.600K

Bianco intenso  
Intense white



+30% di luce  
+30% more light



KRIPTON LIGHTS

### H1 -P14,5s

Coppia lampadine alogene Krypton

Pair halogen krypton lamps



### H3 -PK22s

Coppia lampadine alogene Krypton

Pair halogen krypton lamps



12960

2pz

12V

55W

BOX



12961

2pz

12V

55W

BOX



### H4 -P43t

Coppia lampadine alogene Krypton

Pair halogen krypton lamps



### H7 -PX26d

Coppia lampadine alogene Krypton

Pair halogen krypton lamps



12962

2pz

12V

60-55W

BOX



12968

2pz

12V

55W

BOX







**Luce bianchissima per un effetto sportivo ed elegante**  
Extra-white light for a sporty and elegant effect

**Effetto simil xenon**  
Simil xenon effect

**4.500K**  
Bianco intenso  
Intense white

**+20% di luce**  
+20% more light

**Xenon effect**  
Luce Bianchissima  
**Blue Diamond**

### H1 -P14,5s

Coppia lampadine alogene  
Blue Diamond

*Pair halogen Blue Diamond  
lamps*



12860	2pz	12V	55W	BOX
-------	-----	-----	-----	-----

### H3 -PK22s

Coppia lampadine alogene  
Blue Diamond

*Pair halogen Blue Diamond  
lamps*



12761	2pz	12V	100W	BOX
12861	2pz	12V	55W	BOX

### H4 -P43t

Coppia lampadine alogene  
Blue Diamond

*Pair halogen Blue Diamond  
lamps*



12862	2pz	12V	60-55W	BOX
-------	-----	-----	--------	-----

### H7 -PX26d

Coppia lampadine alogene  
Blue Diamond

*Pair halogen Blue Diamond  
lamps*



12863	2pz	12V	55W	BOX
-------	-----	-----	-----	-----

### H6W -BAX9s

Coppia lampadine alogene  
Blue Diamond

*Pair halogen Blue Diamond  
lamps*



12858 2pz 12V 6W **BLISTER**

### H8 -PGJ19-1

Lampadina alogena  
Blue Diamond

*Halogen Blue Diamond lamp*



12857 2pz 12V 35W **BLISTER**

### H11-PGJ19-2

Lampadina alogena  
Blue Diamond

*Halogen Blue Diamond lamp*



12859 2pz 12V 55W **BOX**

### W5W -W2,1x9,5d

Coppia lampadine  
Blue Diamond

*Pair Blue Diamond lamps*

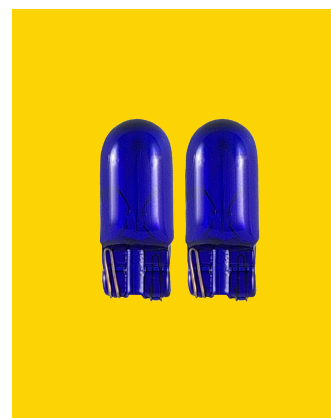

12855 2pz 12V 5W **BLISTER**

### W21/5W- W3x16q

Coppia lampadine alogene  
Blue Diamond

*Pair halogen Blue Diamond  
lamps*



12856 2pz 12V 21-5W **BLISTER**



**KIT LAMPADINE A LED PER CONVERSIONE FARI ALOGENI**  
LED CONVERSION BULB KIT

Altissima emissione luminosa, installabili senza modifiche ai fanali.

Lunga durata, fino a 30.000 ore di utilizzo.  
Raffreddamento con ventola ad alta velocità

*Superbrightness, easy installation without any modification to the original lamps.*

*Long life (30.000 hours).  
High speed cooling fan.*

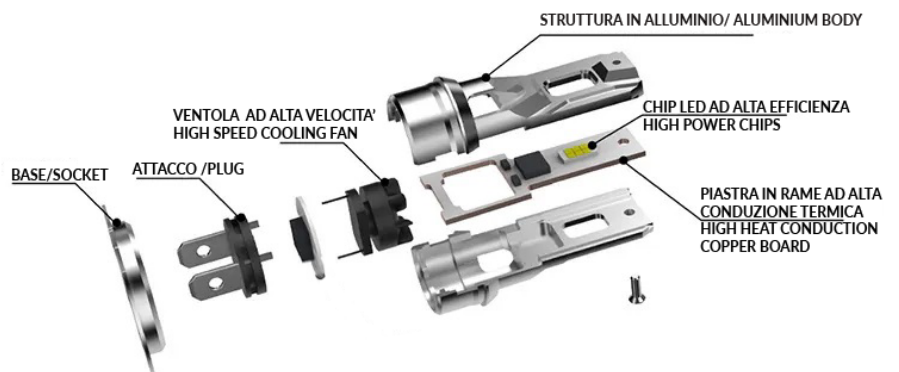



### H1 - P14,5s

Kit LED H1  
*LED kit H1*



12871    2pz    12V    35W    **BOX**

### H4- P43t

Kit LED H4  
*LED kit H4*

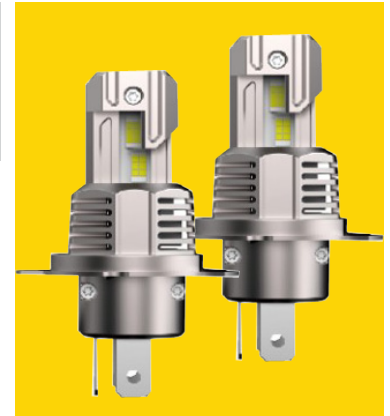

12872    2pz    12V    35W    **BOX**

### H7 - PX26d

Kit LED H7  
*LED kit H7*



12873    2pz    12V    35W    **BOX**

### H11 - PGJ19

Kit LED H11 -H8- H9  
*LED kit H11 -H8- H9*



12874    2pz    12V       **BOX**

### HB3-P20d (9005)

Kit LED HB3 9005  
*LED kit HB3 9005*



12875    2pz    12V    35W    **BOX**

### HB4-P20d (9006)

Kit LED HB4 9006  
*LED kit HB4 9006*

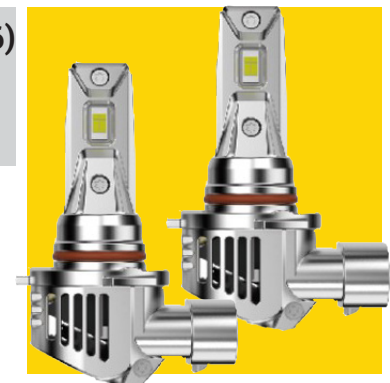

12876    2pz    12V    35    **BOX**



# EXTRA SMALL CON VENTOLA (LA PIÙ PICCOLA SUL MERCATO)

IL KIT A LED DELLA SERIE SMALL LINE È DI DIMENSIONI  
ESTREMAMENTE CONTENUTE E PERTANTO LA SUA

INSTALLAZIONE RISULTA  
POSSIBILE ANCHE DOVE  
LO SPAZIO È RIDOTTO.  
INSTALLAZIONE  
PLUG AND PLAY.



SMALL SIZE ONLY 7 CM

NO ERROR

LUCE FREDDA 6000K

HEAT DISSIPATION FAST  
RAFFREDDAMENTO VELOCE

PLUG AND PLAY

6500  
LUMEN  
PER LAMPADA

ADJUSTABLE  
360° BEAM ANGLE  
ANGOLO FASCIO DI  
LUCE REGOLABILE 360°



H7

HS40852

## LED HEADLIGHTS SET SMALL LINE

(2 PCS.)

- LED POWER: 35W (SINGLE)
- HOUSING MATERIAL: AVIATION ALUMINIUM 6063
- DUAL FAN SYSTEM HEAT DISSIPATION
- DC 9V-32V
- WATERPROOF: IP67
- 6500LM (LUMEN)
- COLOR TEMPERATURE: 6000K
- LIFETIME: >30.000 HOURS
- OPERATING TEMPERATURE: DA -40°C A +80°C
- BEAM ANGLE: 360°

- LED POWER: 35W (SINGLE)
- COMPONENTE LED CHIP DI ELEVATA EFFICIENZA E QUALITÀ, STUDIATO SPECIFICAMENTE PER KIT A LED
- PRODOTTO IN ALLUMINIO 6063
- DOPPIO DISSIPATORE DEL CALORE CON VENTOLA
- DC 9V-32V
- WATERPROOF: IP67
- 6500LM (LUMEN)
- TEMPERATURA COLORE: 6000K
- LIFETIME: >30.000 ORE
- TEMPERATURA OPERATIVA: DA -40°C A +80°C
- ANGOLO FASCIO D'ILLUMINAZIONE REGOLABILE A 360°



H4

HS40851

## LED HEADLIGHTS SET SMALL LINE

(2 PCS.)

- LED POWER: 35W/35W (HIGH/LOW)
- HOUSING MATERIAL: AVIATION ALUMINIUM 6063
- DUAL FAN SYSTEM HEAT DISSIPATION
- DC 9V-32V
- WATERPROOF: IP67
- 6500LM (LUMEN)
- COLOR TEMPERATURE: 6000K
- LIFETIME: >30.000 HOURS
- OPERATING TEMPERATURE: DA -40°C A +80°C
- BEAM ANGLE: 360°

- LED POWER: 35W/35W (HIGH/LOW)
- COMPONENTE LED CHIP DI ELEVATA EFFICIENZA E QUALITÀ, STUDIATO SPECIFICAMENTE PER KIT A LED
- PRODOTTO IN ALLUMINIO 6063
- DOPPIO DISSIPATORE DEL CALORE CON VENTOLA
- DC 9V-32V
- WATERPROOF: IP67
- 6500LM (LUMEN)
- TEMPERATURA COLORE: 6000K
- LIFETIME: >30.000 ORE
- TEMPERATURA OPERATIVA: DA -40°C A +80°C
- ANGOLO FASCIO D'ILLUMINAZIONE REGOLABILE A 360°



H1

HS40856

**LED HEADLIGHTS SET SMALL LINE** (2 PCS.)

- LED POWER: 35W (SINGLE)
- HOUSING MATERIAL: AVIATION ALUMI - NUM 6063
- DUAL FAN SYSTEM HEAT DISSIPATION
- DC 9V-32V
- WATERPROOF: IP67
- 6500LM (LUMEN)
- COLOR TEMPERATURE: 6000K
- LIFETIME: >30.000 HOURS
- OPERATING TEMPERATURE: DA -40°C A +80°C
- BEAM ANGLE: 360°

- LED POWER: 35W (SINGLE)
- COMPONENTE LED CHIP DI ELEVATA EFFICIENZA E QUALITÀ, STUDIATO SPECIFICAMENTE PER KIT A LED
- PRODOTTO IN ALLUMINIO 6063
- DOPPIO DISSIPATORE DEL CALORE CON VENTOLA
- DC 9V-32V
- WATERPROOF: IP67
- 6500LM (LUMEN)
- TEMPERATURA COLORE: 60000K
- LIFETIME: >30.000 ORE
- TEMPERATURA OPERATIVA: DA -40°C A +80°C
- ANGOLO FASCIO D'ILLUMINAZIONE REGOLABILE A 360°

H11-H8-H9-H16



HS40853

**LED HEADLIGHTS SET SMALL LINE** (2 PCS.)

- LED POWER: 35W (SINGLE)
- HOUSING MATERIAL: AVIATION ALUMI - NUM 6063
- DUAL FAN SYSTEM HEAT DISSIPATION
- DC 9V-32V
- WATERPROOF: IP67
- 6500LM (LUMEN)
- COLOR TEMPERATURE: 6000K
- LIFETIME: >30.000 HOURS
- OPERATING TEMPERATURE: DA -40°C A +80°C
- BEAM ANGLE: 360°

- LED POWER: 35W (SINGLE)
- COMPONENTE LED CHIP DI ELEVATA EFFICIENZA E QUALITÀ, STUDIATO SPECIFICAMENTE PER KIT A LED
- PRODOTTO IN ALLUMINIO 6063
- DOPPIO DISSIPATORE DEL CALORE CON VENTOLA
- DC 9V-32V
- WATERPROOF: IP67
- 6500LM (LUMEN)
- TEMPERATURA COLORE: 6000K
- LIFETIME: >30.000 ORE
- TEMPERATURA OPERATIVA: DA -40°C A +80°C
- ANGOLO FASCIO D'ILLUMINAZIONE REGOLABILE A 360°

HB3-9005



HS40854

**LED HEADLIGHTS SET SMALL LINE** (2 PCS.)

- LED POWER: 35W (SINGLE)
- HOUSING MATERIAL: AVIATION ALUMI - NUM 6063
- DUAL FAN SYSTEM HEAT DISSIPATION
- DC 9V-32V
- WATERPROOF: IP67
- 6500LM (LUMEN)
- COLOR TEMPERATURE: 6000K
- LIFETIME: >30.000 HOURS
- OPERATING TEMPERATURE: DA -40°C A +80°C
- BEAM ANGLE: 360°

- LED POWER: 35W (SINGLE)
- COMPONENTE LED CHIP DI ELEVATA EFFICIENZA E QUALITÀ, STUDIATO SPECIFICAMENTE PER KIT A LED
- PRODOTTO IN ALLUMINIO 6063
- DOPPIO DISSIPATORE DEL CALORE CON VENTOLA
- DC 9V-32V
- WATERPROOF: IP67
- 6500LM (LUMEN)
- TEMPERATURA COLORE: 6000K
- LIFETIME: >30.000 ORE
- TEMPERATURA OPERATIVA: DA -40°C A +80°C
- ANGOLO FASCIO D'ILLUMINAZIONE REGOLABILE A 360°

HB4-9006



HS40857

**LED HEADLIGHTS SET SMALL LINE** (2 PCS.)

- LED POWER: 35W (SINGLE)
- HOUSING MATERIAL: AVIATION ALUMI - NUM 6063
- DUAL FAN SYSTEM HEAT DISSIPATION
- DC 9V-32V
- WATERPROOF: IP67
- 6500LM (LUMEN)
- COLOR TEMPERATURE: 6000K
- LIFETIME: >30.000 HOURS
- OPERATING TEMPERATURE: DA -40°C A +80°C
- BEAM ANGLE: 360°

- LED POWER: 35W (SINGLE)
- COMPONENTE LED CHIP DI ELEVATA EFFICIENZA E QUALITÀ, STUDIATO SPECIFICAMENTE PER KIT A LED
- PRODOTTO IN ALLUMINIO 6063
- DOPPIO DISSIPATORE DEL CALORE CON VENTOLA
- DC 9V-32V
- WATERPROOF: IP67
- 6500LM (LUMEN)
- TEMPERATURA COLORE: 6000K
- LIFETIME: >30.000 ORE
- TEMPERATURA OPERATIVA: DA -40°C A +80°C
- ANGOLO FASCIO D'ILLUMINAZIONE REGOLABILE A 360°





HIR2-9012



HS40855

LED HEADLIGHTS SET SMALL LINE (2 PCS.)

- LED POWER: 35W (SINGLE)
- HOUSING MATERIAL: AVIATION ALUMINIUM 6063
- DUAL FAN SYSTEM HEAT DISSIPATION
- DC 9V-32V
- WATERPROOF: IP67
- 6500LM (LUMEN)
- COLOR TEMPERATURE: 6000K
- LIFETIME: >30.000 HOURS
- OPERATING TEMPERATURE: DA -40°C A +80°C
- BEAM ANGLE: 360°
- COMPONENTE LED CHIP DI ELEVATA EFFICIENZA E QUALITÀ, STUDIATO SPECIFICAMENTE PER KIT A LED
- PRODOTTO IN ALLUMINIO 6063
- DOPPIO DISSIPATORE DEL CALORE CON VENTOLA
- DC 9V-32V
- WATERPROOF: IP67
- 6500LM (LUMEN)
- TEMPERATURA COLORE: 6000K
- LIFETIME: >30.000 ORE
- TEMPERATURA OPERATIVA: DA -40°C A +80°C
- ANGOLO FASCIO D'ILLUMINAZIONE REGOLABILE A 360°

# PLUG AND PLAY SHORT LINE

STESSE DIMENSIONI DELL'ORIGINALE

NON NECESSITA DI ADATTORI



HS40852 H7

ALUMINIUM  
LIGHT BOY

PLUG AND PLAY

12 V - 35 WATT

# PLUG AND PLAY ENTRY LEVEL

KIT A LED DI SEMPLICE INSTALLAZIONE GRAZIE ALLA TECNOLOGIA PLUG AND PLAY.

IL KIT A LED PRO PUÒ ESSERE UTILIZZATO PER GLI ANABBAGLIANTI  
E SOPRATTUTTO PER FENDINEBBIA ED ABBAGLIANTI GRAZIE ALLA SUA  
PRATICITÀ DI UTILIZZO.



SMALL SIZE AS HALOGEN BULB  
DIMENSIONI UGUALI LAMPADA ALOGENA

ALUMINUM LIGHT BODY

4500 LUMEN

PLUG AND PLAY

HS40552 H7



## KIT FARI A LED PLUG AND PLAY (COMPOSTO DA 2 PEZZI)

- LED POWER: 30W (SINGLE)
- COMPONENTE LED CHIP DI ELEVATA EFFICIENZA E QUALITÀ, STUDIATO SPECIFICAMENTE PER KIT A LED
- PRODOTTO IN ALLUMINIO
- DOTATO DI DISSIPATORE DEL CALORE
- DC 9V-16V
- INPUT 1.2A±0.1A
- WATERPROOF: IP67
- 4500LM (LUMEN)
- TEMPERATURA COLORE: 6000K
- LIFETIME: >10.000 ORE
- TEMPERATURA OPERATIVA: DA -50°C A +90°C

HS40551 H4



## KIT FARI A LED PLUG AND PLAY (COMPOSTO DA 2 PEZZI)

- LED POWER: 30W (HIGH/LOW)
- COMPONENTE LED CHIP DI ELEVATA EFFICIENZA E QUALITÀ, STUDIATO SPECIFICAMENTE PER KIT A LED
- PRODOTTO IN ALLUMINIO
- DOTATO DI DISSIPATORE DEL CALORE
- DC 9V-16V
- INPUT 1.2A±0.1A
- WATERPROOF: IP67
- 4500LM (LUMEN)
- TEMPERATURA COLORE: 6000K
- LIFETIME: >10.000 ORE
- TEMPERATURA OPERATIVA: DA -50°C A +90°C



**H11-H8-H9**

**HS40553**



**KIT FARI A LED PLUG AND PLAY** (COMPOSTO DA 2 PEZZI)

- LED POWER: 30W (SINGLE)
- COMPONENTE LED CHIP DI ELEVATA EFFICIENZA E QUALITÀ, STUDIATO SPECIFICAMENTE PER KIT A LED
- PRODOTTO IN ALLUMINIO
- DOTATO DI DISSIPATORE DEL CALORE
- DC 9V-16V
- INPUT 1.2A±0.1A
- WATERPROOF: IP67
- 4500LM (LUMEN)
- TEMPERATURA COLORE: 6000K
- LIFETIME: >10.000 ORE
- TEMPERATURA OPERATIVA: DA -50°C A +90°C

**HS40556**

**H1**

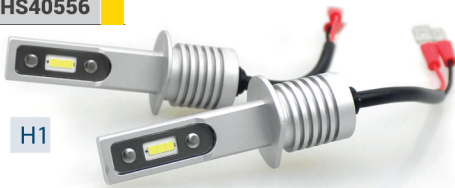

**KIT FARI A LED PLUG AND PLAY** (COMPOSTO DA 2 PEZZI)

- LED POWER: 30W (SINGLE)
- COMPONENTE LED CHIP DI ELEVATA EFFICIENZA E QUALITÀ, STUDIATO SPECIFICAMENTE PER KIT A LED
- PRODOTTO IN ALLUMINIO
- DOTATO DI DISSIPATORE DEL CALORE
- DC 9V-16V
- INPUT 1.2A±0.1A
- WATERPROOF: IP67
- 4500LM (LUMEN)
- TEMPERATURA COLORE: 6000K
- LIFETIME: >10.000 ORE
- TEMPERATURA OPERATIVA: DA -50°C A +90°C

**HS40554**

**HB3-9005**



**KIT FARI A LED PLUG AND PLAY** (COMPOSTO DA 2 PEZZI)

- LED POWER: 30W (SINGLE)
- COMPONENTE LED CHIP DI ELEVATA EFFICIENZA E QUALITÀ, STUDIATO SPECIFICAMENTE PER KIT A LED
- PRODOTTO IN ALLUMINIO
- DOTATO DI DISSIPATORE DEL CALORE
- DC 9V-16V
- INPUT 1.2A±0.1A
- WATERPROOF: IP67
- 4500LM (LUMEN)
- TEMPERATURA COLORE: 6000K
- LIFETIME: >10.000 ORE
- TEMPERATURA OPERATIVA: DA -50°C A +90°C

**HS40559**

**H3**



**KIT FARI A LED PLUG AND PLAY** (COMPOSTO DA 2 PEZZI)

- LED POWER: 30W (SINGLE)
- COMPONENTE LED CHIP DI ELEVATA EFFICIENZA E QUALITÀ, STUDIATO SPECIFICAMENTE PER KIT A LED
- PRODOTTO IN ALLUMINIO
- DOTATO DI DISSIPATORE DEL CALORE
- DC 9V-16V
- INPUT 1.2A±0.1A
- WATERPROOF: IP67
- 4500LM (LUMEN)
- TEMPERATURA COLORE: 6000K
- LIFETIME: >10.000 ORE
- TEMPERATURA OPERATIVA: DA -50°C A +90°C

**HS40558**

**H15**



**KIT FARI A LED PLUG AND PLAY** (COMPOSTO DA 2 PEZZI)

- LED POWER: 30W (HIGH/LOW)
- COMPONENTE LED CHIP DI ELEVATA EFFICIENZA E QUALITÀ, STUDIATO SPECIFICAMENTE PER KIT A LED
- PRODOTTO IN ALLUMINIO
- DOTATO DI DISSIPATORE DEL CALORE
- DC 9V-16V
- INPUT 1.2A±0.1A
- WATERPROOF: IP67
- 4500LM (LUMEN)
- TEMPERATURA COLORE: 6000K
- LIFETIME: >10.000 ORE
- TEMPERATURA OPERATIVA: DA -50°C A +90°C

# EXTRA SMALL

IL KIT A LED DELLA SERIE  
SMALL LINE È DI DIMENSIONI  
ESTREMAMENTE CONTENUTE E  
PERTANTO LA SUA INSTALLAZIONE  
RISULTA POSSIBILE ANCHE DOVE  
LO SPAZIO È RIDOTTO.  
INSTALLAZIONE PLUG AND PLAY.



SMALL SIZE ONLY 7 CM  
DIMENSIONI RIDOTTE SOLO 7 CM

HEAT DISSIPATION FAST  
RAFFREDDAMENTO VELOCE

SUPER CAN BUS

ADJUSTABLE  
360° BEAM ANGLE  
ANGOLO FASCIO DI  
LUCE REGOLABILE 360°

NO  
ERROR



6000 LUMEN  
PER LAMPADA

PLUG AND PLAY





**HS40802** H7

**HS40822** H18



**LED HEADLIGHTS SET SMALL LINE (2 PCS.)**

- LED POWER: 28W (SINGLE)
- HOUSING MATERIAL: AVIATION ALUMINUM 6063
- DUAL FAN SYSTEM HEAT DISSIPATION
- DC 9V-32V
- WATERPROOF: IP67
- 6000LM (LUMEN)
- COLOR TEMPERATURE: 6000K
- LIFETIME: >30.000 HOURS
- OPERATING TEMPERATURE: DA -40°C A +80°C
- BEAM ANGLE: 360°

- LED POWER: 28W (SINGLE)
- COMPONENTE LED CHIP DI ELEVATA EFFICIENZA E QUALITÀ, STUDIATO SPECIFICAMENTE PER KIT A LED
- PRODOTTO IN ALLUMINIO 6063
- DOPPIO DISSIPATORE DEL CALORE CON VENTOLA
- DC 9V-32V
- WATERPROOF: IP67
- 6000LM (LUMEN)
- TEMPERATURA COLORE: 60000K
- LIFETIME: >30.000 ORE
- TEMPERATURA OPERATIVA: DA -40°C A +80°C
- ANGOLO FASCIO D'ILLUMINAZIONE REGOLABILE A 360°

**HS40801** H4

**HS40823** H19



**LED HEADLIGHTS SET SMALL LINE (2 PCS.)**

- LED POWER: 28W/28W (HIGH/LOW)
- HOUSING MATERIAL: AVIATION ALUMINUM 6063
- DUAL FAN SYSTEM HEAT DISSIPATION
- DC 9V-32V
- WATERPROOF: IP67
- 6000LM (LUMEN)
- COLOR TEMPERATURE: 6000K
- LIFETIME: >30.000 HOURS
- OPERATING TEMPERATURE: DA -40°C A +80°C
- BEAM ANGLE: 360°

- LED POWER: 28W/28W (HIGH/LOW)
- COMPONENTE LED CHIP DI ELEVATA EFFICIENZA E QUALITÀ, STUDIATO SPECIFICAMENTE PER KIT A LED
- PRODOTTO IN ALLUMINIO 6063
- DOPPIO DISSIPATORE DEL CALORE CON VENTOLA
- DC 9V-32V
- WATERPROOF: IP67
- 6000LM (LUMEN)
- TEMPERATURA COLORE: 60000K
- LIFETIME: >30.000 ORE
- TEMPERATURA OPERATIVA: DA -40°C A +80°C
- ANGOLO FASCIO D'ILLUMINAZIONE REGOLABILE A 360°

**HS40803** H11-H8-H9-H16



**LED HEADLIGHTS SET SMALL LINE (2 PCS.)**

- LED POWER: 28W (SINGLE)
- HOUSING MATERIAL: AVIATION ALUMINUM 6063
- DUAL FAN SYSTEM HEAT DISSIPATION
- DC 9V-32V
- WATERPROOF: IP67
- 6000LM (LUMEN)
- COLOR TEMPERATURE: 6000K
- LIFETIME: >30.000 HOURS
- OPERATING TEMPERATURE: DA -40°C A +80°C
- BEAM ANGLE: 360°

- LED POWER: 28W (SINGLE)
- COMPONENTE LED CHIP DI ELEVATA EFFICIENZA E QUALITÀ, STUDIATO SPECIFICAMENTE PER KIT A LED
- PRODOTTO IN ALLUMINIO 6063
- DOPPIO DISSIPATORE DEL CALORE CON VENTOLA
- DC 9V-32V
- WATERPROOF: IP67
- 6000LM (LUMEN)
- TEMPERATURA COLORE: 60000K
- LIFETIME: >30.000 ORE
- TEMPERATURA OPERATIVA: DA -40°C A +80°C
- ANGOLO FASCIO D'ILLUMINAZIONE REGOLABILE A 360°

HS40804

HB3-9005



LED HEADLIGHTS SET SMALL LINE (2 PCS.)

- LED POWER: 28W (SINGLE)
- HOUSING MATERIAL: AVIATION ALUMINUM 6063
- DUAL FAN SYSTEM HEAT DISSIPATION
- DC 9V-32V
- WATERPROOF: IP67
- 6000LM (LUMEN)
- COLOR TEMPERATURE: 6000K
- LIFETIME: >30.000 HOURS
- OPERATING TEMPERATURE: DA -40°C A +80°C
- BEAM ANGLE: 360°

- LED POWER: 28W (SINGLE)
- COMPONENTE LED CHIP DI ELEVATA EFFICIENZA E QUALITÀ, STUDIATO SPECIFICAMENTE PER KIT A LED
- PRODOTTO IN ALLUMINIO 6063
- DOPPIO DISSIPATORE DEL CALORE CON VENTOLA
- DC 9V-32V
- WATERPROOF: IP67
- 6000LM (LUMEN)
- TEMPERATURA COLORE: 60000K
- LIFETIME: >30.000 ORE
- TEMPERATURA OPERATIVA: DA -40°C A +80°C
- ANGOLO FASCIO D'ILLUMINAZIONE REGOLABILE A 360°

HS40807

HB4-9006



LED HEADLIGHTS SET SMALL LINE (2 PCS.)

- LED POWER: 28W (SINGLE)
- HOUSING MATERIAL: AVIATION ALUMINUM 6063
- DUAL FAN SYSTEM HEAT DISSIPATION
- DC 9V-32V
- WATERPROOF: IP67
- 6000LM (LUMEN)
- COLOR TEMPERATURE: 6000K
- LIFETIME: >30.000 HOURS
- OPERATING TEMPERATURE: DA -40°C A +80°C
- BEAM ANGLE: 360°

- LED POWER: 28W (SINGLE)
- COMPONENTE LED CHIP DI ELEVATA EFFICIENZA E QUALITÀ, STUDIATO SPECIFICAMENTE PER KIT A LED
- PRODOTTO IN ALLUMINIO 6063
- DOPPIO DISSIPATORE DEL CALORE CON VENTOLA
- DC 9V-32V
- WATERPROOF: IP67
- 6000LM (LUMEN)
- TEMPERATURA COLORE: 60000K
- LIFETIME: >30.000 ORE
- TEMPERATURA OPERATIVA: DA -40°C A +80°C
- ANGOLO FASCIO D'ILLUMINAZIONE REGOLABILE A 360°

HS40805

HIR2-9012



LED HEADLIGHTS SET SMALL LINE (2 PCS.)

- LED POWER: 28W (SINGLE)
- HOUSING MATERIAL: AVIATION ALUMINUM 6063
- DUAL FAN SYSTEM HEAT DISSIPATION
- DC 9V-32V
- WATERPROOF: IP67
- 6000LM (LUMEN)
- COLOR TEMPERATURE: 6000K
- LIFETIME: >30.000 HOURS
- OPERATING TEMPERATURE: DA -40°C A +80°C
- BEAM ANGLE: 360°

- LED POWER: 28W (SINGLE)
- COMPONENTE LED CHIP DI ELEVATA EFFICIENZA E QUALITÀ, STUDIATO SPECIFICAMENTE PER KIT A LED
- PRODOTTO IN ALLUMINIO 6063
- DOPPIO DISSIPATORE DEL CALORE CON VENTOLA
- DC 9V-32V
- WATERPROOF: IP67
- 6000LM (LUMEN)
- TEMPERATURA COLORE: 60000K
- LIFETIME: >30.000 ORE
- TEMPERATURA OPERATIVA: DA -40°C A +80°C
- ANGOLO FASCIO D'ILLUMINAZIONE REGOLABILE A 360°



# GOLD LINE LENTICOLARE



IL KIT A LED DELLA SERIE GOLD LENTICOLARE È STUDIATO SPECIFICAMENTE PER DARE LA MASSIMA ILLUMINAZIONE SUI FARI LENTICOLARI, PERTANTO È SCONSIGLIATA L'INSTALLAZIONE SU FARI SPROVVISTI DI LENTE.

ALUMINUM LIGHT BODY

10.000 LUMEN

48 WATT CAN BUS ULTIMA GENERAZIONE

HS40902 H7  
HS40922 H18

LENTICOLARE

10.000 LUMEN



## LED HEADLIGHTS SET LENTICOLARE (LENS) (2 PCS.)

- LED POWER: 48W (SINGLE)
- COMPONENTE LED CHIP DI ELEVATA EFFICIENZA E QUALITÀ, STUDIATO SPECIFICAMENTE PER KIT A LED
- PRODOTTO IN ALLUMINIO 6063
- DOPPIO DISSIPATORE DEL CALORE CON VENTOLA
- DC 9V-32V
- WATERPROOF: IP67
- 6000LM (LUMEN)
- TEMPERATURA COLORE: 6000K
- LIFETIME: >30.000 ORE
- TEMPERATURA OPERATIVA: DA -50°C A +90°C
- ANGOLO FASCIO D'ILLUMINAZIONE REGOLABILE A 180°

HS40903 H11

LENTICOLARE

10.000 LUMEN



## LED HEADLIGHTS SET LENTICOLARE (LENS) (2 PCS.)

- LED POWER: 48W (SINGLE)
- COMPONENTE LED CHIP DI ELEVATA EFFICIENZA E QUALITÀ, STUDIATO SPECIFICAMENTE PER KIT A LED
- PRODOTTO IN ALLUMINIO 6063
- DOPPIO DISSIPATORE DEL CALORE CON VENTOLA
- DC 9V-32V
- WATERPROOF: IP67
- 6000LM (LUMEN)
- TEMPERATURA COLORE: 6000K
- LIFETIME: >30.000 ORE
- TEMPERATURA OPERATIVA: DA -50°C A +90°C
- ANGOLO FASCIO D'ILLUMINAZIONE REGOLABILE A 180°



HS40904 HB3-9005

LENTICOLARE

10.000 LUMEN



LED HEADLIGHTS SET LENTICOLARE (LENS) (2 PCS.)

- LED POWER: 48W (SINGLE)
- COMPONENTE LED CHIP DI ELEVATA EFFICIENZA E QUALITÀ, STUDIATO SPECIFICAMENTE PER KIT A LED
- PRODOTTO IN ALLUMINIO 6063
- DOPPIO DISSIPATORE DEL CALORE CON VENTOLA
- DC 9V-32V
- WATERPROOF: IP67
- 6000LM (LUMEN)
- TEMPERATURA COLORE: 6000K
- LIFETIME: >30.000 ORE
- TEMPERATURA OPERATIVA: DA -50°C A +90°C
- ANGOLO FASCIO D'ILLUMINAZIONE REGOLABILE A 180°

HS40905 HIR2-9012

LENTICOLARE

10.000 LUMEN



LED HEADLIGHTS SET LENTICOLARE (LENS) (2 PCS.)

- LED POWER: 48W (SINGLE)
- COMPONENTE LED CHIP DI ELEVATA EFFICIENZA E QUALITÀ, STUDIATO SPECIFICAMENTE PER KIT A LED
- PRODOTTO IN ALLUMINIO 6063
- DOPPIO DISSIPATORE DEL CALORE CON VENTOLA
- DC 9V-32V
- WATERPROOF: IP67
- 6000LM (LUMEN)
- TEMPERATURA COLORE: 6000K
- LIFETIME: >30.000 ORE
- TEMPERATURA OPERATIVA: DA -50°C A +90°C
- ANGOLO FASCIO D'ILLUMINAZIONE REGOLABILE A 180°

SPECIFICO HB3-9005 MOTORIZZATO (EVOQUE, ETC.)

HS40917

LENTICOLARE  
MOTORIZZATO

6.000 LUMEN



LED HEADLIGHTS SET LENTICOLARE (LENS) (2 PCS.)

- LED POWER: 48W (SINGLE)
- COMPONENTE LED CHIP DI ELEVATA EFFICIENZA E QUALITÀ, STUDIATO SPECIFICAMENTE PER KIT A LED
- PRODOTTO IN ALLUMINIO 6063
- DOPPIO DISSIPATORE DEL CALORE CON VENTOLA
- DC 9V-32V
- WATERPROOF: IP67
- 6000LM (LUMEN)
- TEMPERATURA COLORE: 6000K
- LIFETIME: >30.000 ORE
- TEMPERATURA OPERATIVA: DA -50°C A +90°C
- ANGOLO FASCIO D'ILLUMINAZIONE REGOLABILE A 180°

\*VERSIONE MOTORIZZATA SI INTENDE QUANDO CON UN'UNICA LAMPADINA SI AGISCE SIA SU ANABBAGLIANTI CHE ABBAGLIANTI

SPECIFICO HIR2-9012 MOTORIZZATO (TOYOTA, ETC.)

HS40918

LENTICOLARE  
MOTORIZZATO

6.000 LUMEN



LED HEADLIGHTS SET LENTICOLARE (LENS) (2 PCS.)

- LED POWER: 48W (SINGLE)
- COMPONENTE LED CHIP DI ELEVATA EFFICIENZA E QUALITÀ, STUDIATO SPECIFICAMENTE PER KIT A LED
- PRODOTTO IN ALLUMINIO 6063
- DOPPIO DISSIPATORE DEL CALORE CON VENTOLA
- DC 9V-32V
- WATERPROOF: IP67
- 6000LM (LUMEN)
- TEMPERATURA COLORE: 6000K
- LIFETIME: >30.000 ORE
- TEMPERATURA OPERATIVA: DA -50°C A +90°C
- ANGOLO FASCIO D'ILLUMINAZIONE REGOLABILE A 180°

\*VERSIONE MOTORIZZATA SI INTENDE QUANDO CON UN'UNICA LAMPADINA SI AGISCE SIA SU ANABBAGLIANTI CHE ABBAGLIANTI

H1

HS40906

LENTICOLARE

6.000 LUMEN



LED HEADLIGHTS SET LENTICOLARE (LENS) (2 PCS.)

- LED POWER: 48W (SINGLE)
- COMPONENTE LED CHIP DI ELEVATA EFFICIENZA E QUALITÀ, STUDIATO SPECIFICAMENTE PER KIT A LED
- PRODOTTO IN ALLUMINIO 6063
- DOPPIO DISSIPATORE DEL CALORE CON VENTOLA
- DC 9V-32V
- WATERPROOF: IP67
- 6000LM (LUMEN)
- TEMPERATURA COLORE: 6000K
- LIFETIME: >30.000 ORE
- TEMPERATURA OPERATIVA: DA -50°C A +90°C
- ANGOLO FASCIO D'ILLUMINAZIONE REGOLABILE A 180°





**HS41061**  

**DOPPIO FILAMENTO**  
**60 LED - 1200 LM**

**FULL CAN BUS**  
(VENTOLA INTERNA DI RAFFREDDAMENTO)

- 60\*3623SMD
- LED SAMSUNG
- CAN BUS
- H: 680±20MA - L: 80±10MA
- REVERSE POLARITY PROTECTION
- CONSTANT CURRENT IC
- SURGE VOLTAGE 18V
- 12V-16.5V
- 1157

- LAMPADA DI POSIZIONE A LED
- BAY15D - 1157 - P21W/5W
- DOPPIO FILAMENTO
- CAN BUS NO ERROR
- 12 VOLT
- 60 LED ALTA LUMINOSITA'
- 1200LM
- WHITE 5500K

**HS41060**  

**SINGOLO FILAMENTO**  
**60 LED - 1200 LM**

**FULL CAN BUS**  
(VENTOLA INTERNA DI RAFFREDDAMENTO)

- 60\*3623SMD
- LED SAMSUNG
- CAN BUS
- 680±20MA
- NO-POLARITY
- CONSTANT CURRENT IC
- SURGE VOLTAGE 18V
- 12V-16.5V
- 1156

- LAMPADA DI POSIZIONE A LED
- BA15S - 1156 - P21W
- SINGOLO FILAMENTO
- CAN BUS NO ERROR
- 12 VOLT
- 60 LED ALTA LUMINOSITA'
- 1200LM
- WHITE 5500K

**HS41051**  

**DOPPIO FILAMENTO**  
**60 LED - 1200 LM**

**FULL CAN BUS**  
(VENTOLA INTERNA DI RAFFREDDAMENTO)

- 60\*3623SMD
- LED SAMSUNG
- CAN BUS
- H: 680±20MA - L: 80±10MA
- REVERSE POLARITY PROTECTION
- CONSTANT CURRENT IC
- SURGE VOLTAGE 18V
- 12V-16.5V
- 7443

- LAMPADA DI POSIZIONE A LED
- T20 - 7443 - W21W /5W
- DOPPIO FILAMENTO
- CAN BUS NO ERROR
- 12 VOLT
- 60 LED ALTA LUMINOSITA'
- 1200LM - WHITE 5500K

**HS41050**  

**SINGOLO FILAMENTO**  
**60 LED - 1200 LM**

**FULL CAN BUS**  
(VENTOLA INTERNA DI RAFFREDDAMENTO)

- 60\*3623SMD
- LED SAMSUNG
- CANBUS
- 680± 20MA
- NO-POLARITY
- CONSTANT CURRENT IC
- SURGE VOLTAGE 18V
- 12V-16.5V
- 7440

- LAMPADA DI POSIZIONE A LED
- T20 - 7440 - W21W
- SINGOLO FILAMENTO
- CAN BUS NO ERROR
- 12 VOLT
- 60 LED ALTA LUMINOSITA'
- 1200LM
- WHITE 5500K

**HS41062**  

**60 LED - 1200 LM**  
**LUCE FRECCIE COLOR ARANCIO**

**FULL CAN BUS**  
(VENTOLA INTERNA DI RAFFREDDAMENTO)

- 60\*3623SMD
- LED SAMSUNG
- CANBUS
- 680± 20MA
- NO-POLARITY
- CONSTANT CURRENT IC
- SURGE VOLTAGE 18V
- 12V-16.5V
- 7440

- LAMPADA FRECCIE A LED
- PY21W - S25 - BAU15
- 12V - 21W
- SINGOLO FILAMENTO
- CAN BUS NO ERROR
- 12 VOLT
- 60 LED ALTA LUMINOSITA'
- 1200LM
- LUCE ARANCIONE FRECCIE

**NON NECESSITA DI RESISTENZA.  
IL TEMPO DI INTERMITTENZA RIMANE INVARIATO.**

HS43160



LUCE FREDDA  
6000K

SINGOLO FILAMENTO

- INPUT (MA): 450±20
- 12/24 VOLT
- LUMENS (LM): 800
- LED QUANTITY: 13 SMD
- PCB: ALUMINUM SUBSTRATE
- BEAM ANGLE: 360°
- LAMPADA DI POSIZIONE A LED
- USAGE: BACK-UP LIGHT, TURNING LIGHT, TAIL LIGHT
- BA15S - 1156 - P21W
- SINGOLO FILAMENTO
- CAN BUS NO ERROR
- LUCE BIANCA FREDDA 6000K

HS43161



LUCE FREDDA  
6000K

DOPPIO FILAMENTO

- INPUT (MA): H 450±20 - L 100±20
- 12/24 VOLT
- LUMENS (LM): 800
- LED QUANTITY: 13 SMD
- PCB: ALUMINUM SUBSTRATE
- BEAM ANGLE: 360°
- LAMPADA DI POSIZIONE A LED
- USAGE: BACK-UP LIGHT, TURNING LIGHT, TAIL LIGHT
- BAY15D - 1157 - P21W/5W
- DOPPIO FILAMENTO
- CAN BUS NO ERROR
- LUCE BIANCA FREDDA 6000K

HS43150



LUCE FREDDA  
6000K

SINGOLO FILAMENTO

- INPUT (MA): 450±20
- 12/24 VOLT
- LUMENS (LM): 800
- LED QUANTITY: 13 SMD
- PCB: ALUMINUM SUBSTRATE
- BEAM ANGLE: 360°
- LAMPADA DI POSIZIONE A LED
- USAGE: BACK-UP LIGHT, TURNING LIGHT, TAIL LIGHT
- T20 - 7440 - W21W
- SINGOLO FILAMENTO
- CAN BUS NO ERROR
- LUCE BIANCA FREDDA 6000K

HS43151



LUCE FREDDA  
6000K

DOPPIO FILAMENTO

- INPUT (MA): H 450±20 - L 100±20
- 12/24 VOLT
- LUMENS (LM): 800
- LED QUANTITY: 13 SMD
- PCB: ALUMINUM SUBSTRATE
- BEAM ANGLE: 360°
- LAMPADA DI POSIZIONE A LED
- USAGE: BACK-UP LIGHT, TURNING LIGHT, TAIL LIGHT
- T20/21-5W - 7443 - W21/5W
- DOPPIO FILAMENTO
- CAN BUS NO ERROR
- LUCE BIANCA FREDDA 6000K

HS43162



LUCE FRECC  
COLOR ARANCIONE

SINGOLO FILAMENTO

- INPUT (MA): 450±20
- 12/24 VOLT
- LUMENS (LM): 800
- LED QUANTITY: 13 SMD
- PCB: ALUMINUM SUBSTRATE
- BEAM ANGLE: 360°
- LAMPADA FRECC  
A LED
- USAGE: BACK-UP LIGHT, TURNING LIGHT, TAIL LIGHT
- PY21W - S25 - BAU15S
- SINGOLO FILAMENTO
- CAN BUS NO ERROR
- LUCE ARANCIONE FRECC  
E

HS43163



LUCE POSIZIONE/STOP  
COLOR ROSSO

DOPPIO FILAMENTO

- INPUT (MA): H 450±20 - L 100±20
- 12/24 VOLT
- LUMENS (LM): 800
- LED QUANTITY: 13 SMD
- PCB: ALUMINUM SUBSTRATE
- BEAM ANGLE: 360°
- LAMPADA POSIZIONE/STOP  
A LED
- USAGE: BACK-UP LIGHT, TURNING LIGHT, TAIL LIGHT
- BAY15D - 1157 - P21/5W
- SINGOLO FILAMENTO
- CAN BUS NO ERROR
- LUCE ROSSA POSIZIONE/STOP



**T10  
W5W**

**HS41002**



- 15 LED SMD 4014
- CANBUS
- 250±10MA
- NON-POLARITY
- CONSTANT CURRENT IC
- SURGE VOLTAGE 18V
- 12V-14,5V
- 350 LM
- WHITE 5500K
- LAMPADA DI POSIZIONE A LED
- T10 W5W
- TUTTO VETRO
- CAN BUS NO ERROR
- 12 VOLT
- LUCE BIANCA FREDDA 5500K
- 15 LED ALTA LUMINOSITA'

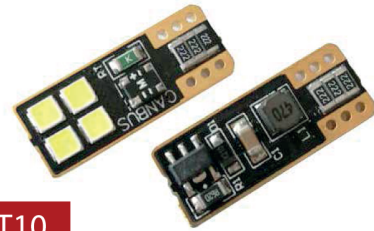

**T10  
W5W**

**HS41004**

- 4\*3623SMD
- LED SAMSUNG
- SUPER CANBUS
- 250±10MA
- NON-POLARITY
- COSTANT CURRENT IC
- SURGE VOLTAGE 18V
- 12V-14,5V
- 300 LM
- WHITE 5500K
- LAMPADA DI POSIZIONE A LED
- T10 W5W
- TUTTO VETRO
- CAN BUS NO ERROR
- 12 VOLT
- LUCE BIANCA FREDDA 5500K
- 4 LED ALTA LUMINOSITA'

**T10  
W5W**

**HS41005**



- 4\*3623SMD
- LED SAMSUNG
- SUPER CANBUS
- 250±10MA
- NON-POLARITY
- COSTANT CURRENT IC
- SURGE VOLTAGE 18V
- 12V-14,5V
- 400 LM
- WHITE 5500K
- LAMPADA DI POSIZIONE A LED
- T10 W5W
- TUTTO VETRO
- CAN BUS NO ERROR
- 12 VOLT - 5W
- LUCE BIANCA FREDDA 5500K
- 4 LED ALTA LUMINOSITA'

**T10  
W5W**

**HS41101**



- CAN BUS
- POWER: 5W
- COLOR: WHITE 5500 K
- LED QUANTITY: 6PCS
- VOLTAGE: DC10V-16V
- BEAM ANGLE: 180°
- USAGE: READING LIGHT, MIRROR LIGHT, LICENSE PLATE LIGHT, WIDTH LIGHT
- LAMPADA DI POSIZIONE A LED
- T10
- CAN BUS NO ERROR
- 12 VOLT
- LUCE BIANCA FREDDA 5500K
- 6 LED ALTA LUMINOSITA'
- W5W (TUTTO VETRO)

**T11  
(SILURO)**

**HS41130**

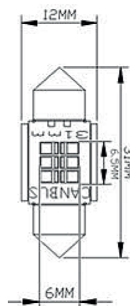

- CAN BUS
- POWER: 5W
- COLOR: WHITE
- LED QUANTITY: 6PCS
- VOLTAGE: DC10V-16V
- BEAM ANGLE: 180°
- LAMPADA DI POSIZIONE A LED
- CAN BUS NO ERROR
- 12 VOLT
- LUCE BIANCA FREDDA 5500K
- 6 LED ALTA LUMINOSITA'
- SILURO 31 MM
- USAGE: READING LIGHT, MIRROR LIGHT, LICENSE PLATE LIGHT, TRUCK LIGHT

**HS41131**

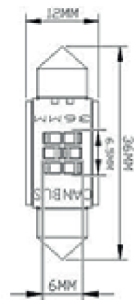

**T11  
(SILURO)**

- CAN BUS
- POWER: 5W
- COLOR: WHITE
- LED QUANTITY: 6PCS
- VOLTAGE: DC10V-16V
- BEAM ANGLE: 180°
- LAMPADA DI POSIZIONE A LED
- CAN BUS NO ERROR
- 12 VOLT
- LUCE BIANCA FREDDA 5500K
- 6 LED ALTA LUMINOSITA'
- SILURO 36 MM
- USAGE: READING LIGHT, MIRROR LIGHT, LICENSE PLATE LIGHT, TRUCK LIGHT

**T11  
(SILURO)**

**HS41132**

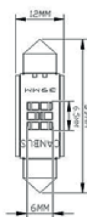

- CAN BUS
- POWER: 5W
- COLOR: WHITE
- LED QUANTITY: 6PCS
- VOLTAGE: DC10V-16V
- BEAM ANGLE: 180°
- LAMPADE DI POSIZIONE A LED
- CAN BUS NO ERROR
- 12 VOLT
- LUCE BIANCA FREDDA 5500K
- 6 LED ALTA LUMINOSITA'
- SILURO 39 MM
- USAGE: READING LIGHT, MIRROR LIGHT, LICENSE PLATE LIGHT, TRUCK LIGHT

**T11  
(SILURO)**

**HS41133**

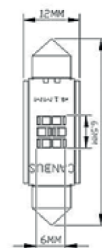

- CAN BUS
- POWER: 5W
- COLOR: WHITE
- LED QUANTITY: 6PCS
- VOLTAGE: DC10V-16V
- BEAM ANGLE: 180°
- LAMPADE DI POSIZIONE A LED
- CAN BUS NO ERROR
- 12 VOLT
- LUCE BIANCA FREDDA 5500K
- 6 LED ALTA LUMINOSITA'
- SILURO 41 MM
- USAGE: READING LIGHT, MIRROR LIGHT, LICENSE PLATE LIGHT, TRUCK LIGHT

**W16W**

**HS41155**



- CAN BUS
- POWER: 15W
- COLOR: WHITE
- LED QUANTITY: 10PCS
- VOLTAGE: DC10V-16V
- BEAM ANGLE: 360°
- LAMPADE DI POSIZIONE/RETROMARCIA A LED
- CAN BUS NO ERROR
- 12 VOLT
- LUCE BIANCA FREDDA 5500K
- 10 LED ALTA LUMINOSITA'
- USAGE: READING LIGHT, MIRROR LIGHT, LICENSE PLATE LIGHT, TRUCK LIGHT

**H7**

**HS40252** 12V

**HS40259** 24V



DIGITAL LED WARNING CANCELLER (H7)  
FILTRO RESISTENZA PER KIT LED H7

**H7**

**HS40256**



NO ERROR WARNING CANCELLER (H7)  
RESISTENZA PER LAMPADA LED H7

- 50W
- 6 OHM

**H4**

**HS40255**



DIGITAL LED WARNING CANCELLER (H4)  
FILTRO RESISTENZA PER KIT LED H4

- BI-LED
- CANBUS NO ERROR 12V 40/40W

**HS40253** H8-H9-H11

**HS40254** 9005-9006-H10-HIR2



DIGITAL LED WARNING CANCELLER (H8 H9 H11 HB3 9005  
HB4 9006 H10 HIR2)  
FILTRO RESISTENZA PER KIT LED (H8 H9 H11 HB3 9005  
HB4 9006 H10 HIR2)

- CANBUS NO ERROR 12V 40W





# KIT A LED "TRUCK LINE" SPECIFICO TRUCK 24 VOLT CAN BUS

PARABOLA &  
LENTICOLARE



HS41062 IVECO STRALIS EURO 4/5/6 NO PROBLEM CON FILTRO

**8000 LUMEN**  
PER LAMPADA

HS40752A - H7

HS40751 - H4

HS40756A - H1

GAMMA COMPLETA LAMPADINE 24V TRUCK



Lampade rotanti per veicoli industriali, mezzi agricoli, mezzi di emergenza o di soccorso. Comodo fissaggio con calamita e collegamento elettrico tramite spinotto accendisigari. Lente in policarbonato.

Rotating lamps for industrial vehicles, agricultural vehicles, emergency or rescue vehicles. Easy fixing with magnet and electrical connection by cigarette lighter plug. Polycarbonate lens.

**LAMPADA ROTANTE 100 LED**  
WARNING LED LIGHT 100LEDS

Lampada di emergenza a 100 led con doppia funzione: intermittente/rotante.

Warning led light with double function: Intermittent flash/ revolving flash.



**DOPPIA FUNZIONE INTERMITTENTE/ROTANTE**  
DOUBLE FUNCTION FLASH/REVOLVING FLASH



**LED**

14128 1pz 12V 21W AMBRA/AMBER



**LAMPADA ROTANTE ALOGENA**  
WARNING HALOGEN LIGHT

Lampada alogena rotante H3. Fissaggio con base magnetica e cavo a spirale.

Revolving halogen light H3. Fixing by magne. Universal cigarette lighter plug and spiral cable.



14125 1pz 12V 55W AMBRA/AMBER



**CALOTTA DI RICAMBIO PER ART. 14125**  
SPARE LENS FOR ART. 14125



14127 1pz BLU/BLUE





**FARI AUSILIARI A LED**

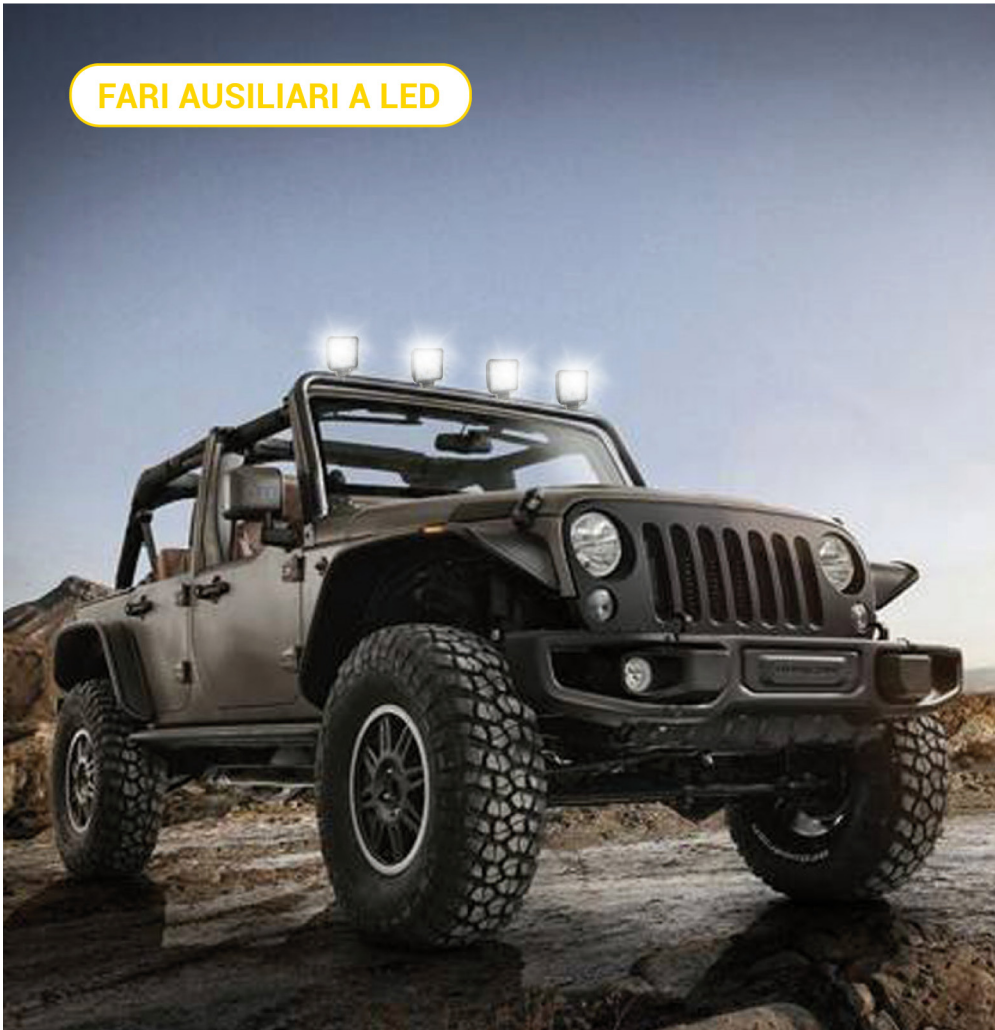

Fari ausiliari alogeni con struttura in acciaio cromato, lente in vetro, viti per il fissaggio e lampadina H3 inclusi. Ideali per fuoristrada e mezzi di lavoro. Non omologato per uso stradale.

*Auxiliary light with chromed housing, glass waterproof lens. Screws for fixing and H3 bulb included in each package. Perfect for off-road and working vehicles. Not approved for use on public roads.*

**ORION FARO DA LAVORO**

*ORION WORKING AUXILIARY LIGHT*

Impermeabile IP67 12-24V 60W 1260LUMEN colore luce 6000K  
Vita: 50000ore.

Resiste senza sforzo a urti e graffi e alle alte temperature.  
È ideale anche per ambienti e condizioni difficili, come nebbia, pioggia e neve.

Le lenti in alluminio verniciato nero e policarbonato proteggono i componenti interni. Il dissipatore di calore integrato consente ai LED di funzionare correttamente e garantisce la loro massima efficienza.

Si adatta perfettamente a tutti i veicoli e dispositivi 12-24V.

*Waterproof IP67 12-24V 60W 1260LUMEN, 6000K Life: 50000hours.*

*Shocks and scratches resistant against high temperatures. It is also ideal for harsh environments and conditions such as fog, rain and snow.*

*Black painted aluminum and polycarbonate lenses protect internal components. The integrated heat sink allows the LEDs to function properly and ensures their maximum efficiency.*

*Fits perfectly in all 12-24V vehicles and devices.*



**14155**

**1pz**

**12V/24V**

**60W**

**ELEKTRA FARO AUSILIARIO A LED**  
ELEKTRA AUXILIARY LIGHT

Faro ausiliario quadrato a 9 led. Fascio luminoso concentrato  
dimensioni 11,5x11,5x4,5cm

*Auxiliary light, square shape with 9 leds, spot beam.  
dimensions 11,5x11,5x4,5cm*

<b>14151</b>	<b>1pz</b>	12-24V	27W
--------------	------------	--------	-----



**LYRA FARO AUSILIARIO A LED**  
LYRA AUXILIARY LIGHT

Faro ausiliario rotondo a 9 led. Fascio luminoso concentrato  
dimensioni 12,5x12,5x4 cm

*Auxiliary light, round shape with 9 leds, spot beam.  
dimensions 12,5x12,5x4 cm*

<b>14152</b>	<b>1pz</b>	12-24V	27W
--------------	------------	--------	-----



**CASSIOPEA FARO AUSILIARIO A LED**  
CASSIOPEA AUXILIARY LIGHT

Faro ausiliario quadrato a 9 led. Fascio luminoso diffuso,  
dimensioni 11,5x11,5x4,5cm

*Auxiliary light, square shape with 9 leds, flood beam.  
dimensions 11,5x11,5x4,5cm*

<b>14153</b>	<b>1pz</b>	12-24V	27W
--------------	------------	--------	-----



**CENTAURUS FARO AUSILIARIO A LED**  
CENTAURUS AUXILIARY LIGHT

Faro ausiliario rotondo a 9 led. Fascio luminoso diffuso,  
dimensioni 12,5x12,5x4 cm

*Auxiliary light, round shape with 9 leds, flood beam.  
dimensions 12,5x12,5x4 cm*

<b>14154</b>	<b>1pz</b>	12-24V	27W
--------------	------------	--------	-----







**FENIX, MICRO PROIETTORI**

*FENIX, MICROPROJECTOR FOG LAMPS*

Coppia micro proiettori bianchi fendinebbia.  
dimensioni 5x5x5 cm

*Pair of micro projector fog lamps.  
dimensions 5x5x5 cm*

**14145** 2pz H3 -12V-55W BIANCO WHITE



**CRYSTAL, FARI FENDINEBBIA**

*CRYSTAL PAIR OF FOG LIGHTS*

Coppia fari fendinebbia  
dimensioni 14x5x7 cm

*Pair of fog lights.  
dimensions 14X5X7 cm*

**14149** 2pz H3 -12V-55W BLU/BLUE



**ANGEL EYES, FARO DI PROFONDITA'**

*ANGEL EYES, DRIVING LIGHT*

Faro di profondità con corona a led blu  
dimensioni 15,5x15,5x12 cm

*Driving light with blue led ring  
dimensions 15,5x15,5x12 cm*

**14144** 1pz H3 12/24V 55-130W BIANCO WHITE



**ANDROMEDA, FARO DI PROFONDITA'**

*ANDROMEDA, DRIVING LIGHT*

Faro di profondità  
dimensioni 15,5x15,5x12 cm

*Driving light  
dimensions 15,5x15,5x12 cm*

**14147** 1pz H3 12/24V 55-130W BLU/BLUE

